

FLOATING DOCK

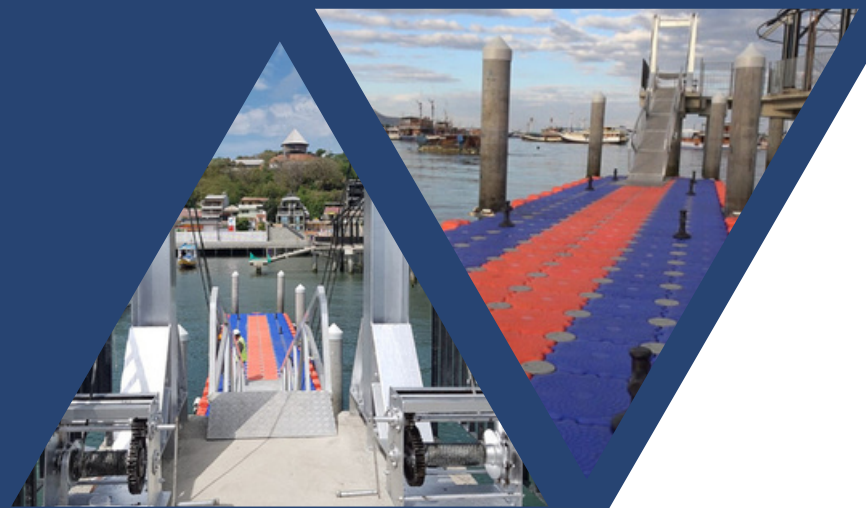



Wakil Gubernur Jawa Tengah Resmikan Bendungan
Pengendugunting, Blora



BROCHURE

SPECIFICATION

Main Dimension : 50 x 50 x 40 cm
 Lock Size : 22 x 25 cm
 Weight : 7 kg/pcs
 Load Capacity : 360 kg/sqm
 Material : HDPE
 Yield Strength : 17.59 Mpa
 Tensile Strength : 21.98 Mpa

CUBE ACCESSORIES

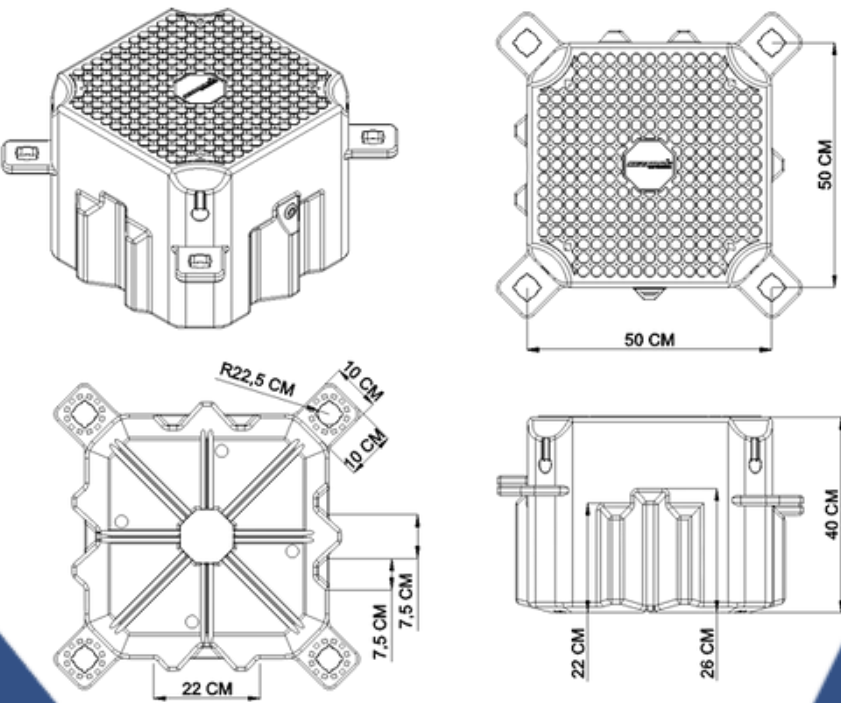

CUBE INSTALLATION

Simple, fast in assembly, diverse in configuration, Seanocs cube is widely used as various purpose. Reasonable cost, from a long-term point of view, it will save much cost and time in maintain and repair. Complete equipment for floating dock system, such a bollard hand rails, crash worthy ball, pill guide etc.



Cube

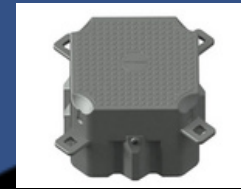

Low Cube



Dapra Rubber Fender



SS304
Bollard



Spanner



Bolt and Nut



Short Pin



Long Bolt



Long Pin

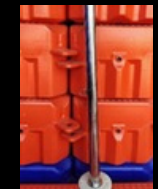

SS304
Railling



V Float



U float



U float with Roller



Pile Guide



Mallet

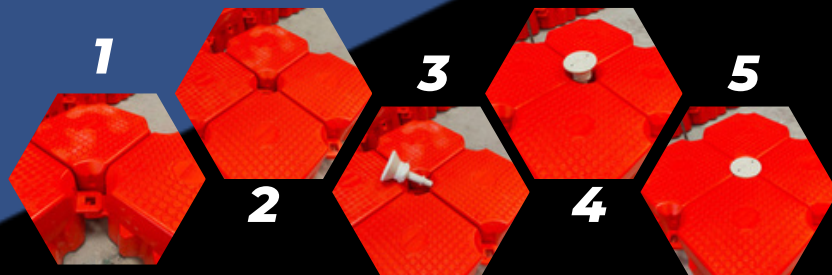

Floating Jetty

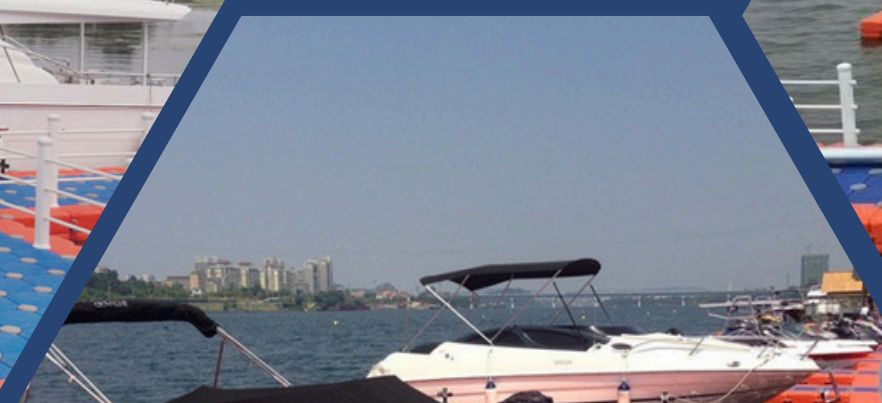

Floating Jet Ski Docks



Floating Platform

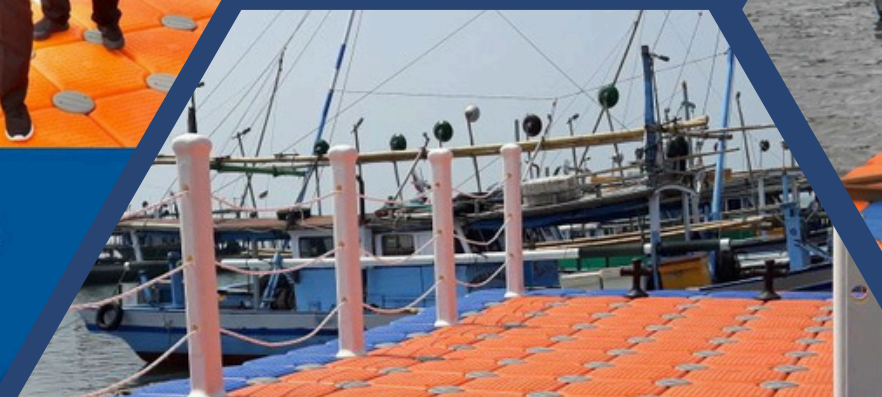

Kowi Resmikan Bendungan
Mugunting, Blora

Floating Bridges

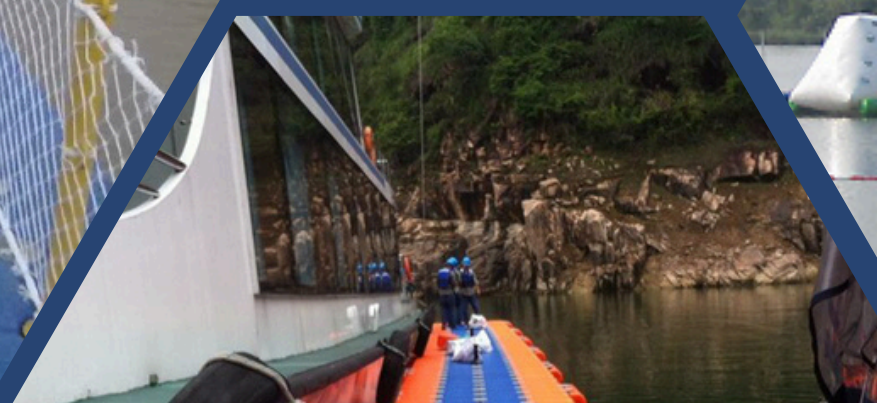

Fish Farm

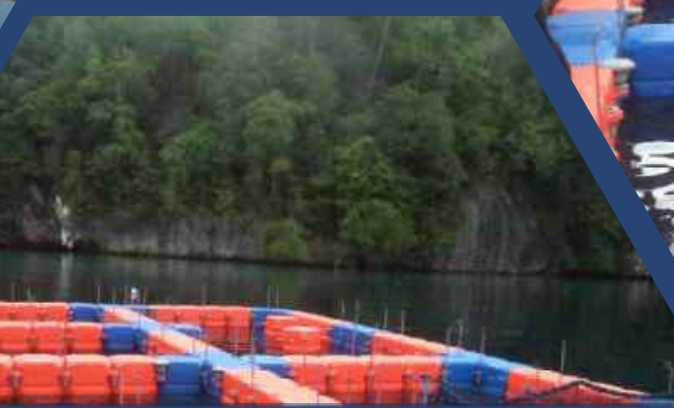
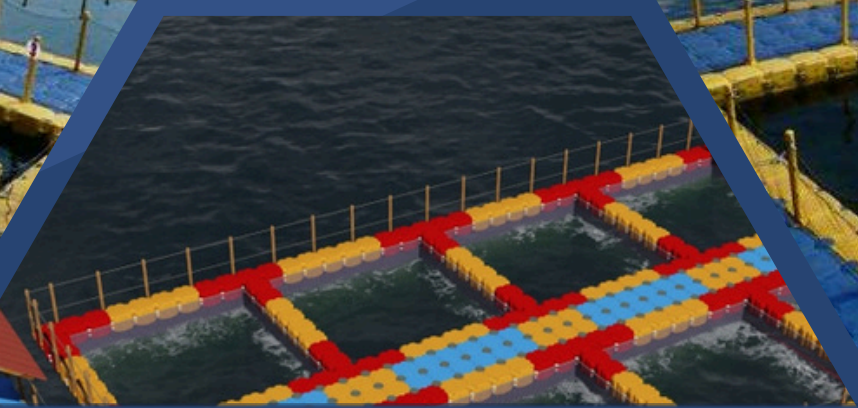
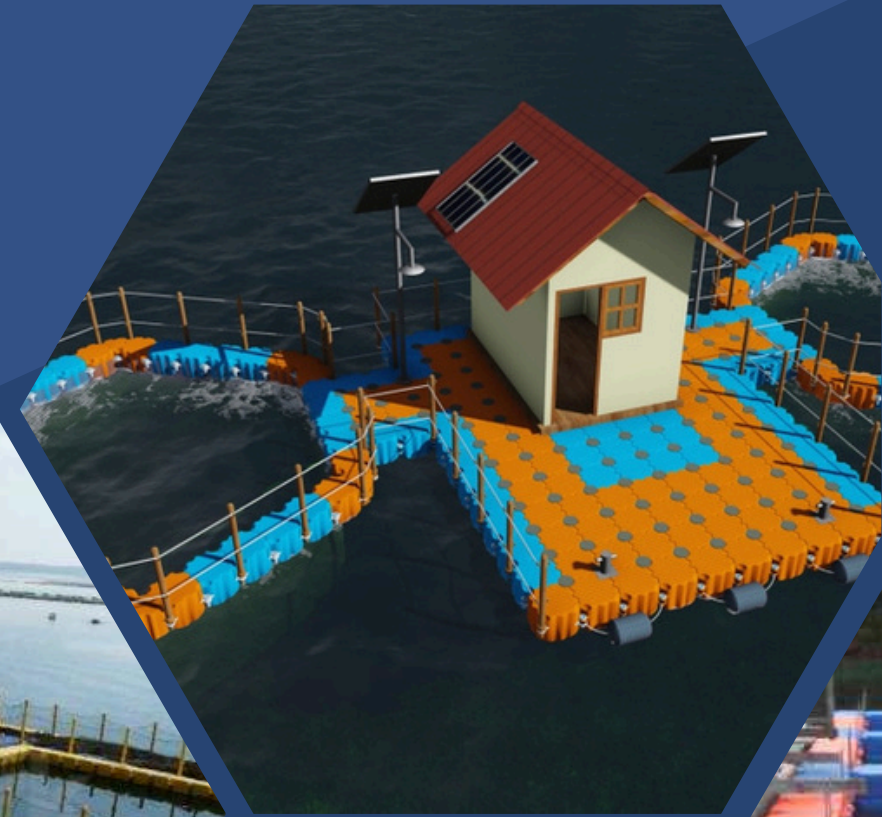

Floating Solar Panel



Floating Resort and Tour



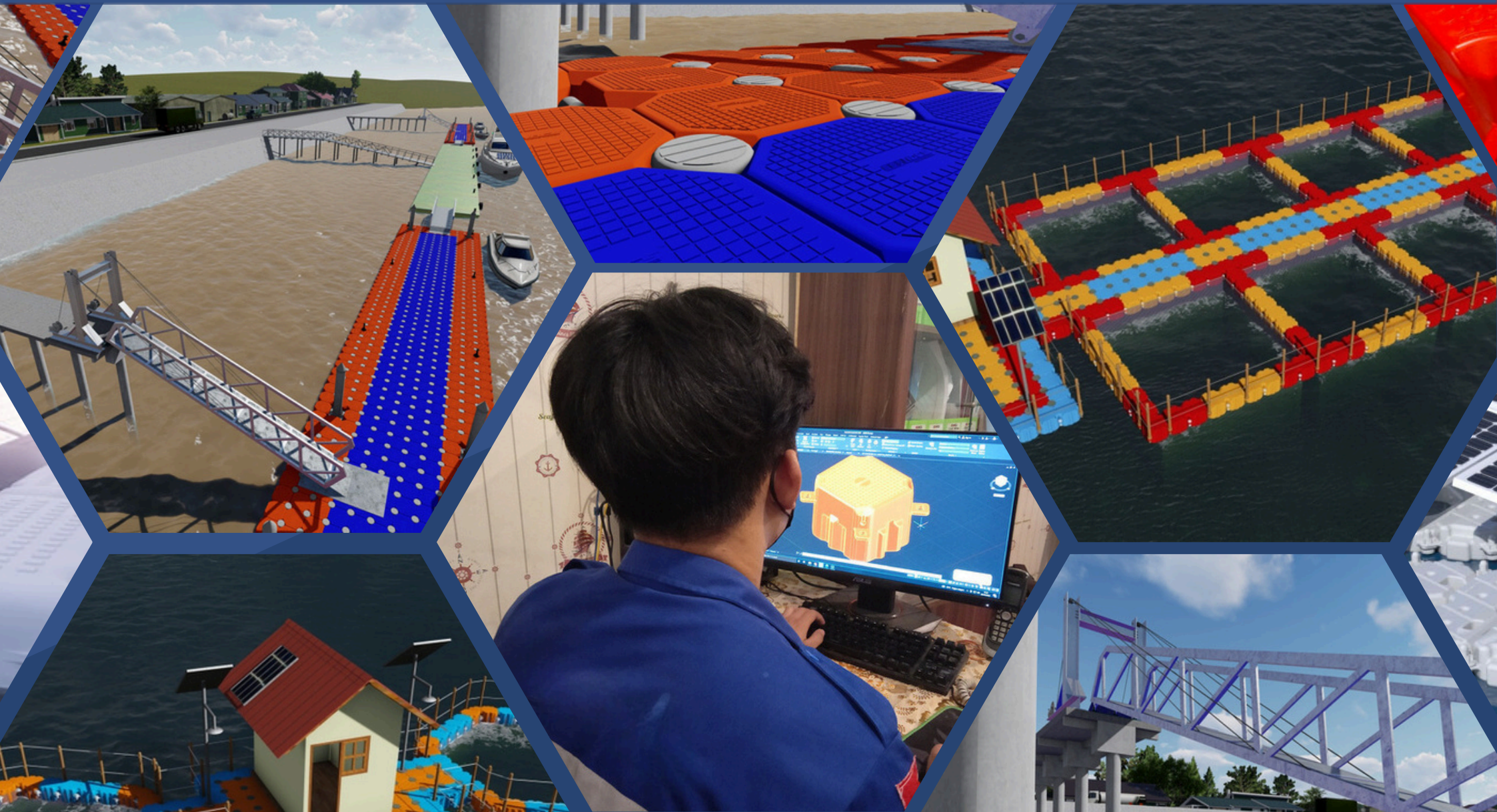

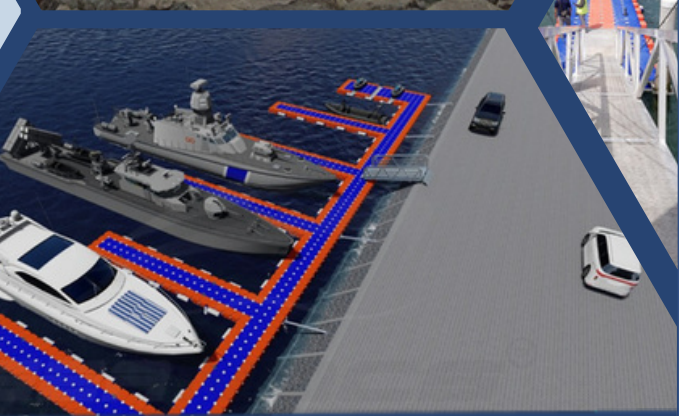

February 24-26, 2023



GALLERY

Dermaga Apung INDOMARINE Pupuk Kaltim & Pupuk FAK-FAK

